

# MANUAL DE ARMADO

Organizador Escolar 21  
cajones 160 Alto

**SKU:YCW-21206**

Este manual de armado ha sido diseñado para ayudarte a ensamblar correctamente tu mobiliario escolar.

Asegúrate de contar con las herramientas necesarias y disponer del tiempo suficiente antes de comenzar el proceso.

Estos productos son distribuidos por EBT S.A.

Si tienes dudas o necesitas asistencia, no dudes en contactarnos a:

[ventas@ebt.cl](mailto:ventas@ebt.cl).

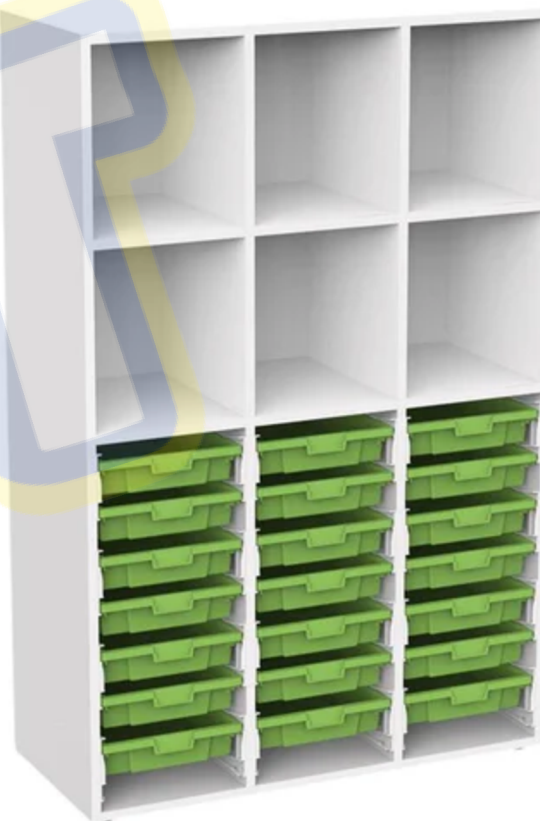

# Manual de Armado

Aplicable para YCW-21206 (caja pequeña)

## Assembly Accessory

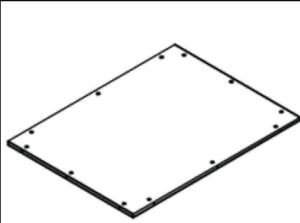
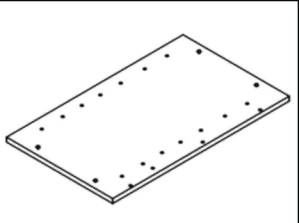
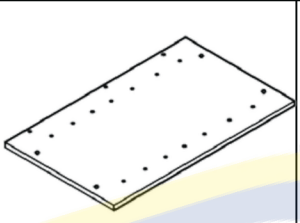
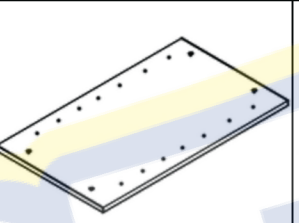
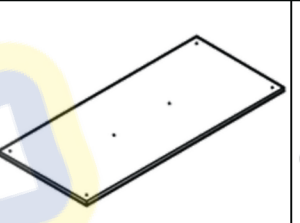
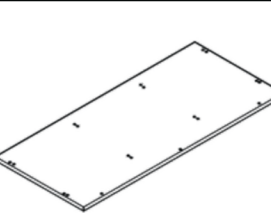
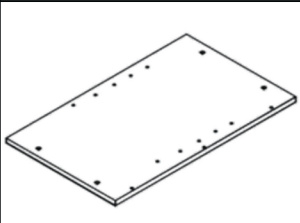
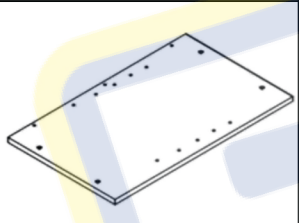
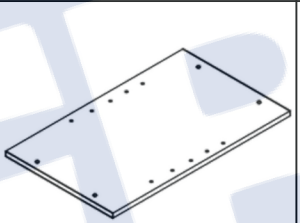
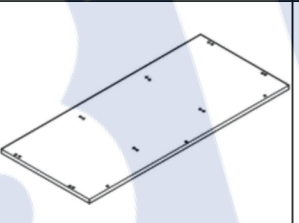
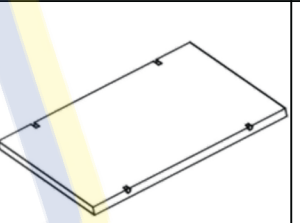
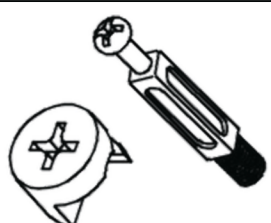
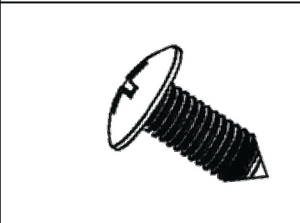
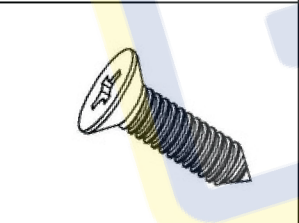
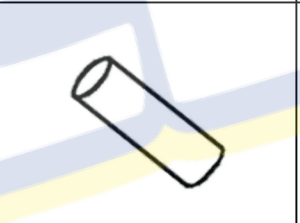
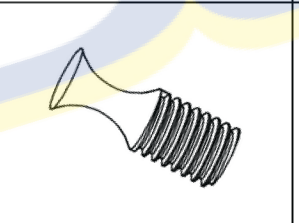
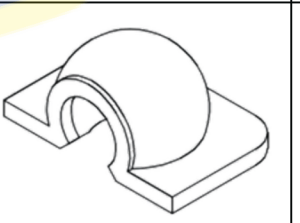
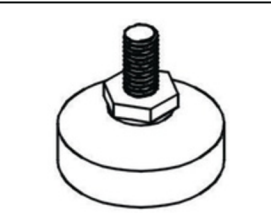
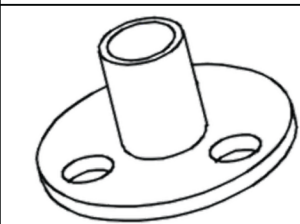
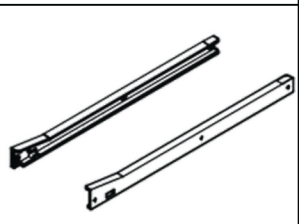
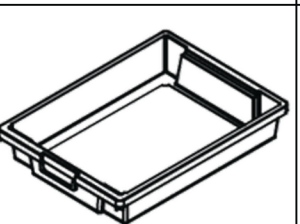
					
1×2pcs	2×1pcs	3×1pcs	4×2pcs	5×1pcs	6×1pcs
					
7×1pcs	8×1pcs	9×2pcs	10×1pcs	11×3pcs	12×56pcs
					
13×126pcs	14×18pcs	15×32pcs	16×12pcs	17×12pcs	18×6pcs
					
19×6pcs	20×(21+21)pcs	21×21pcs			

Para facilitar la instalación, coloque el producto sobre el suelo.  
Antes de instalar, fije las piezas 12, 15 y 20 en sus respectivos paneles. Tenga en cuenta la dirección de instalación de la pieza 20: el saliente debe estar hacia arriba.

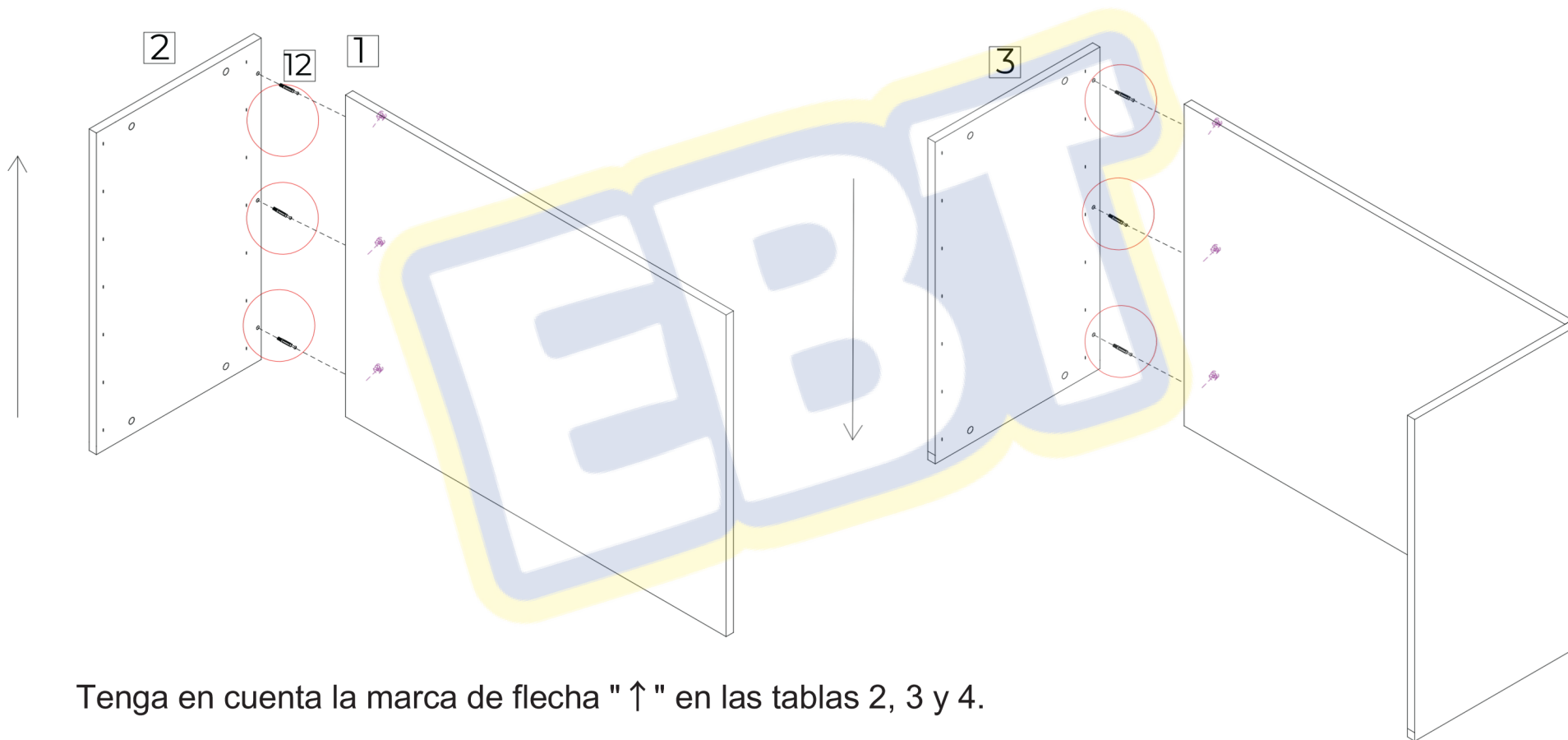
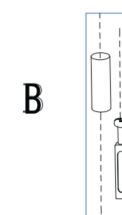
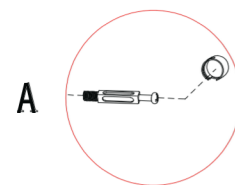

Tenga en cuenta la marca de flecha "↑" en las tablas 2, 3 y 4.

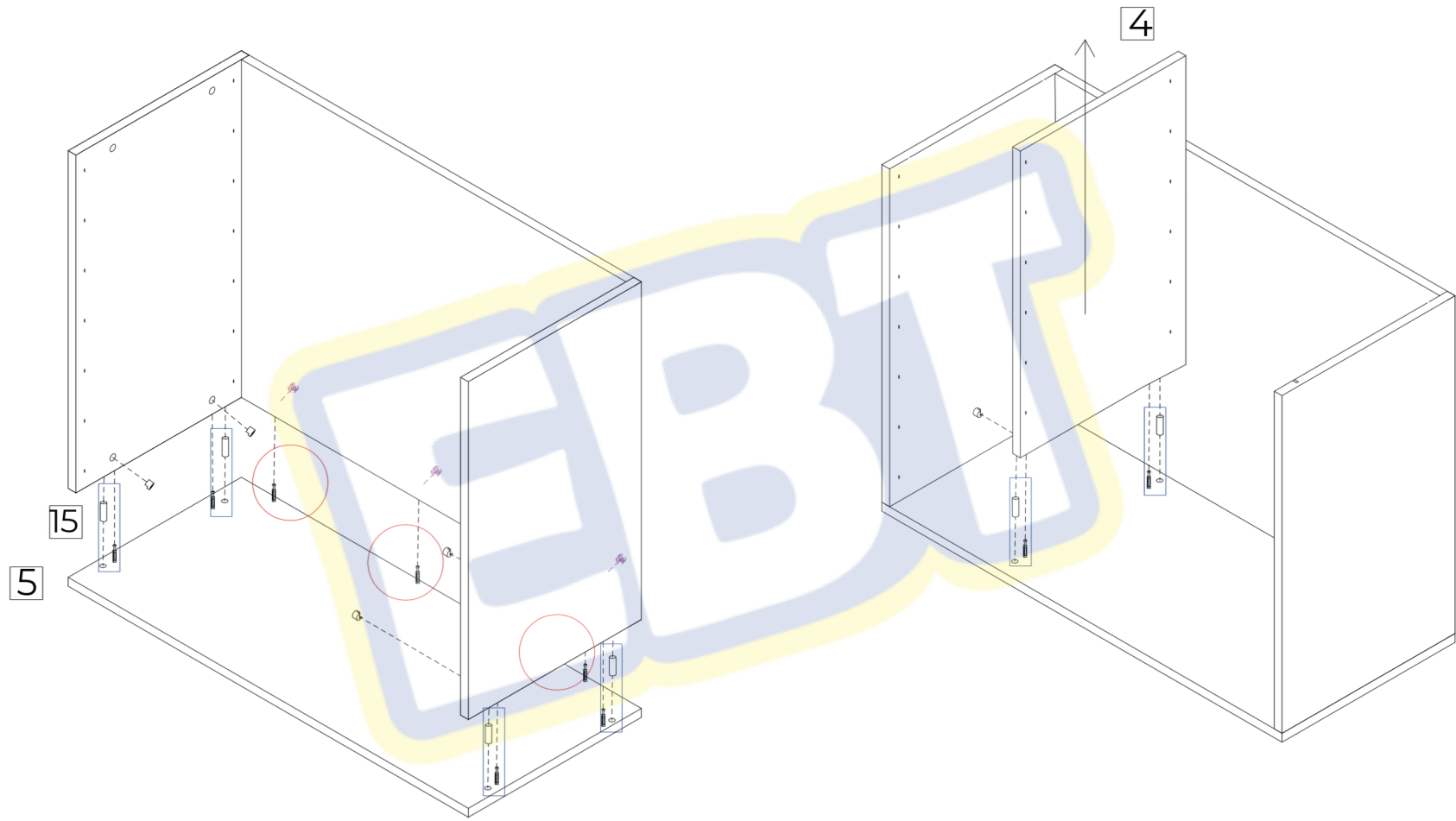

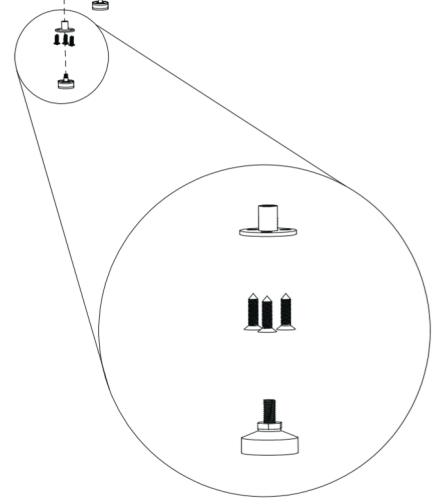
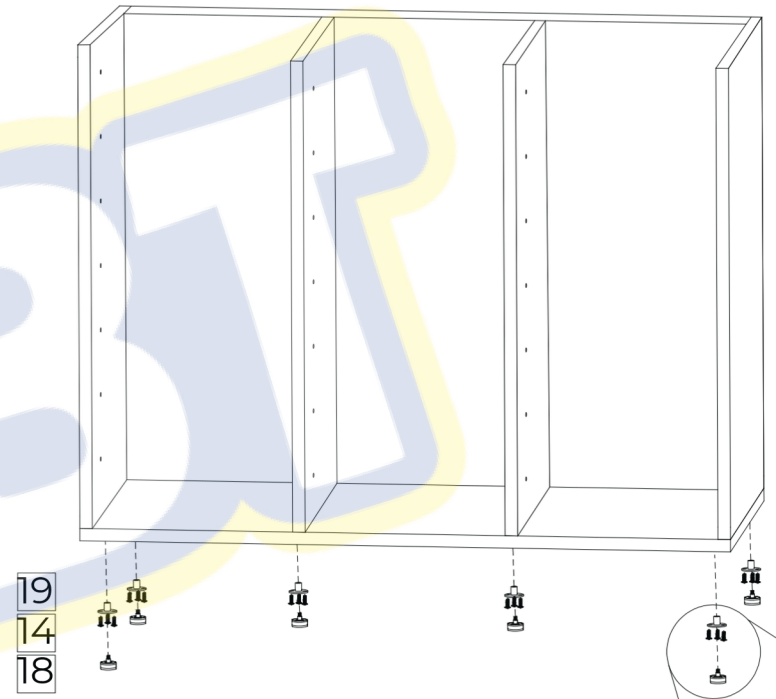
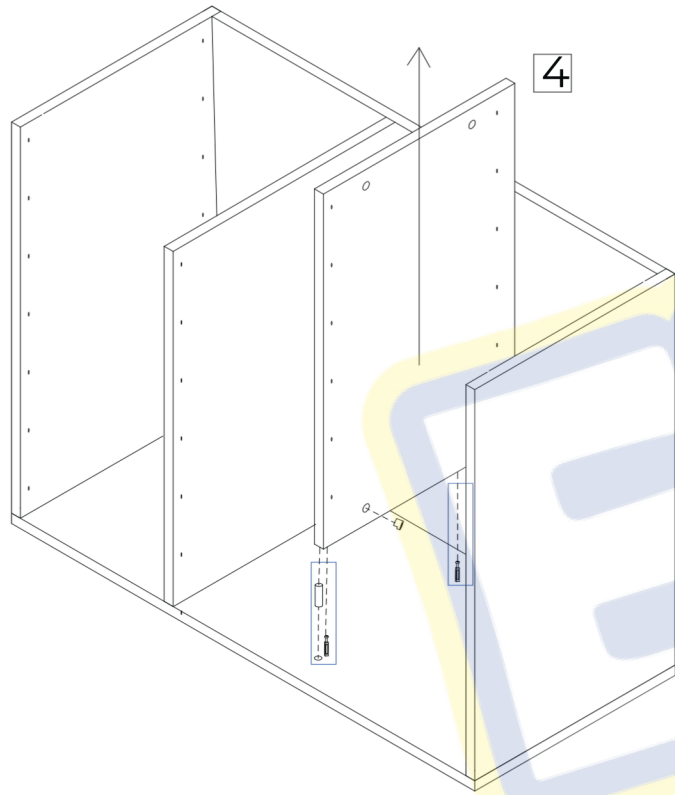

Tenga en cuenta la marca de flecha "↑" en los tableros 7, 8 y 9.

6

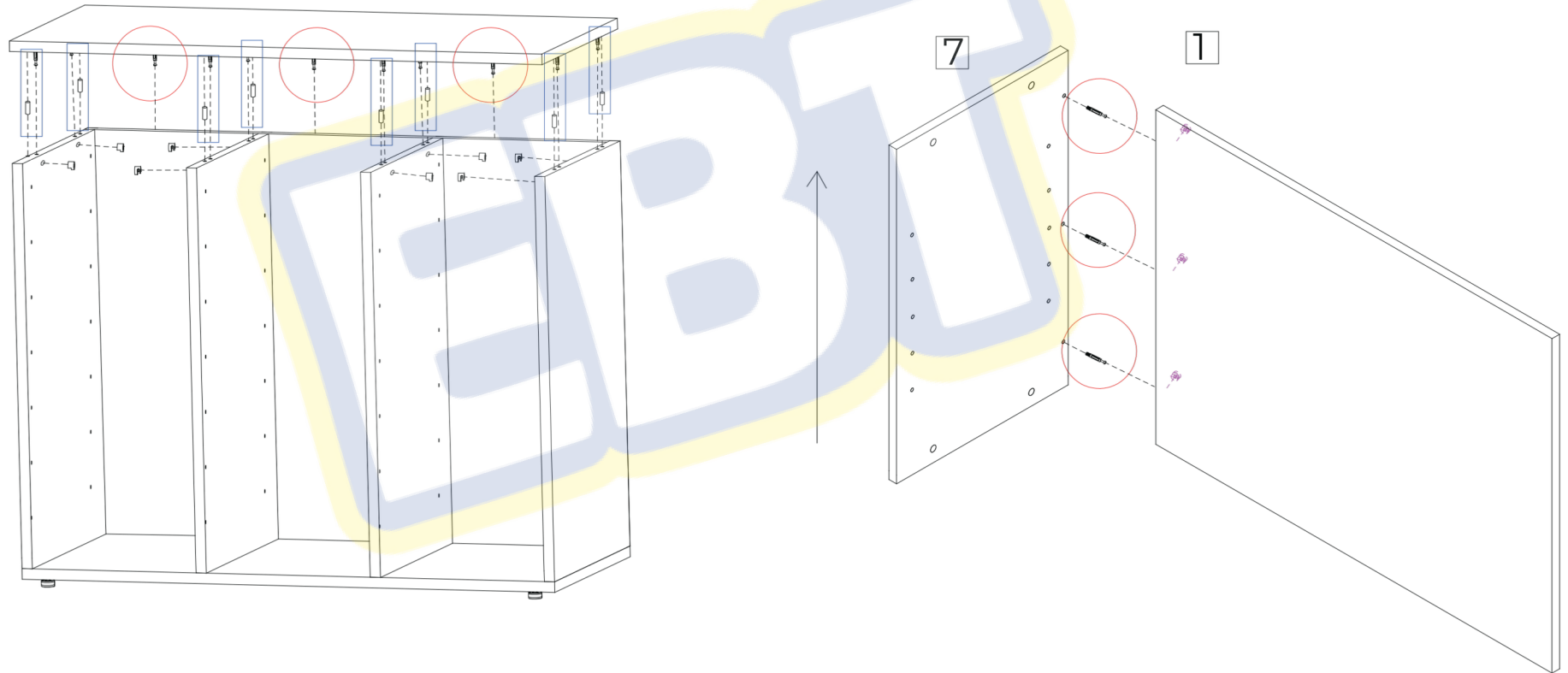

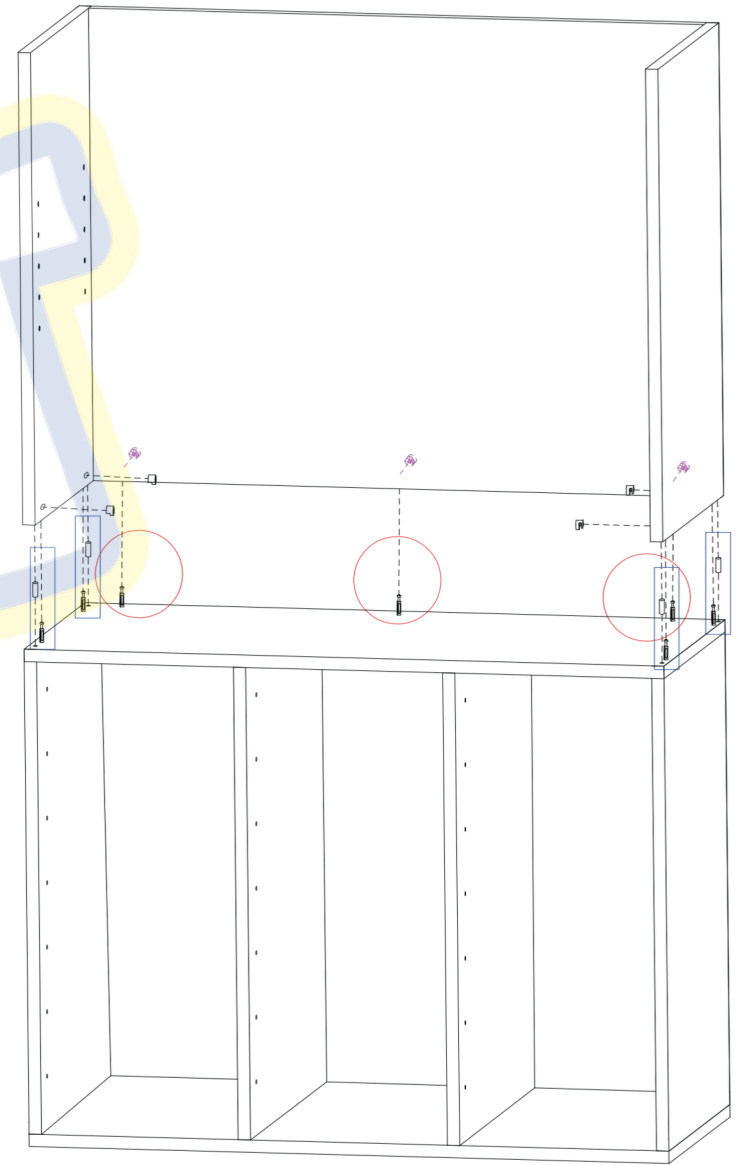
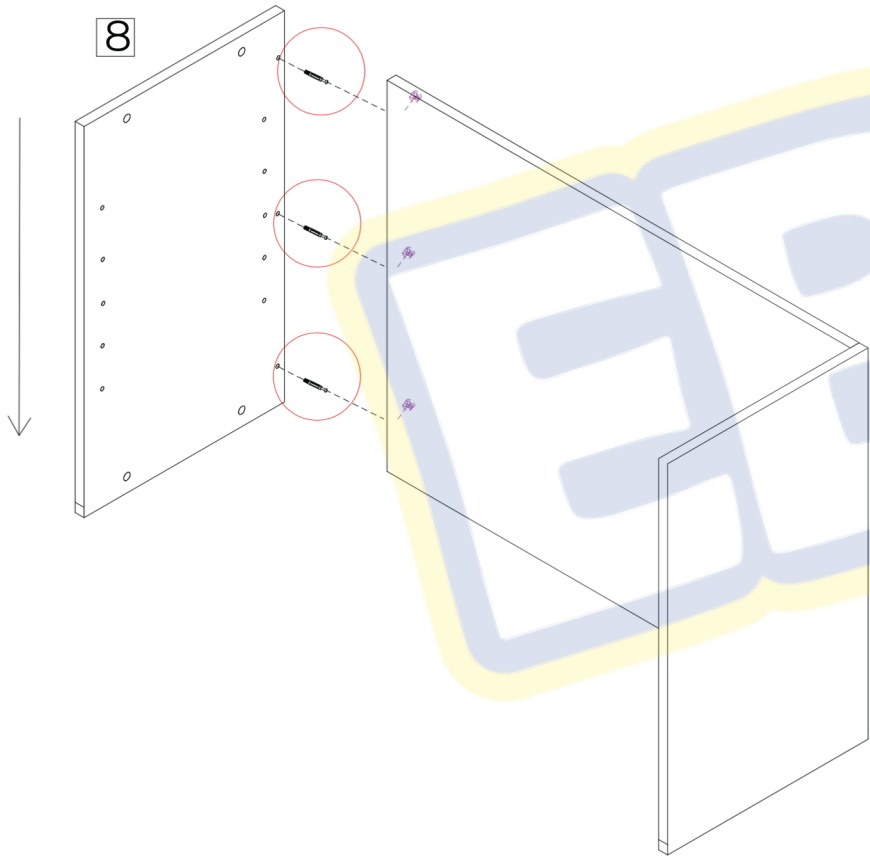

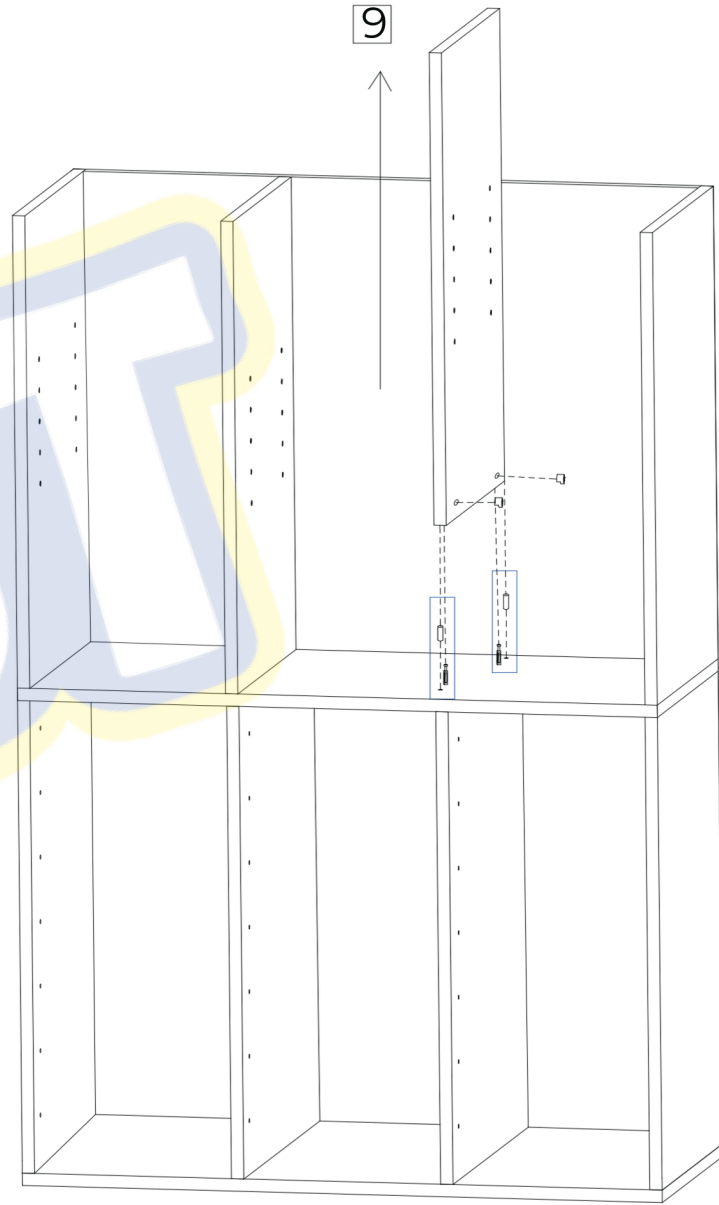
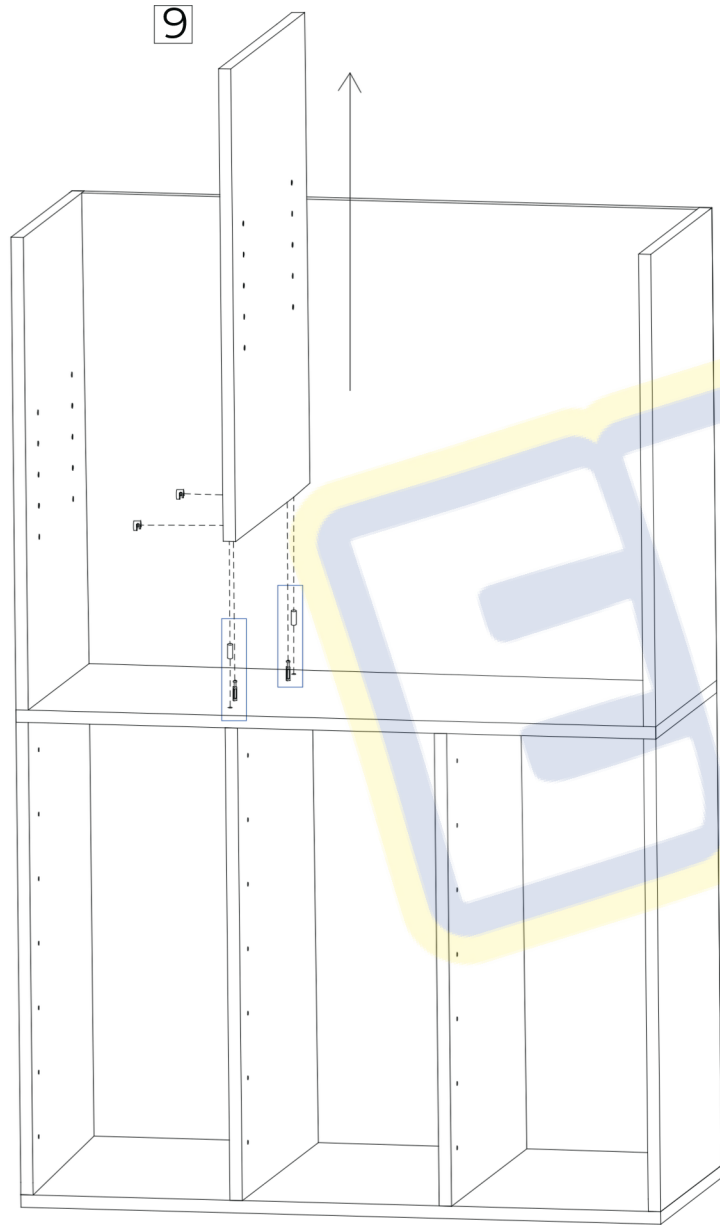



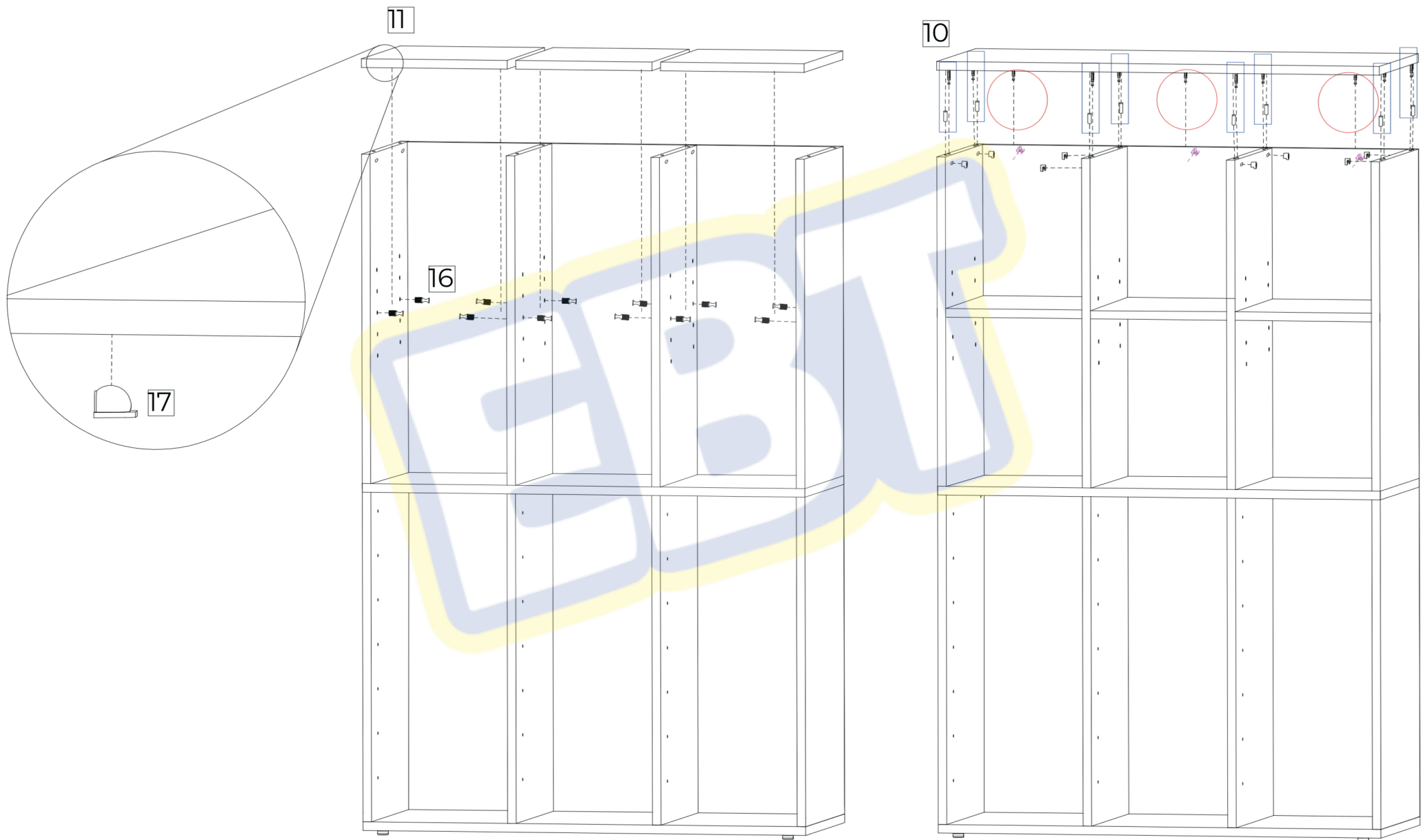

Después de completar este paso de instalación, cubra los orificios con las pegatinas proporcionadas.

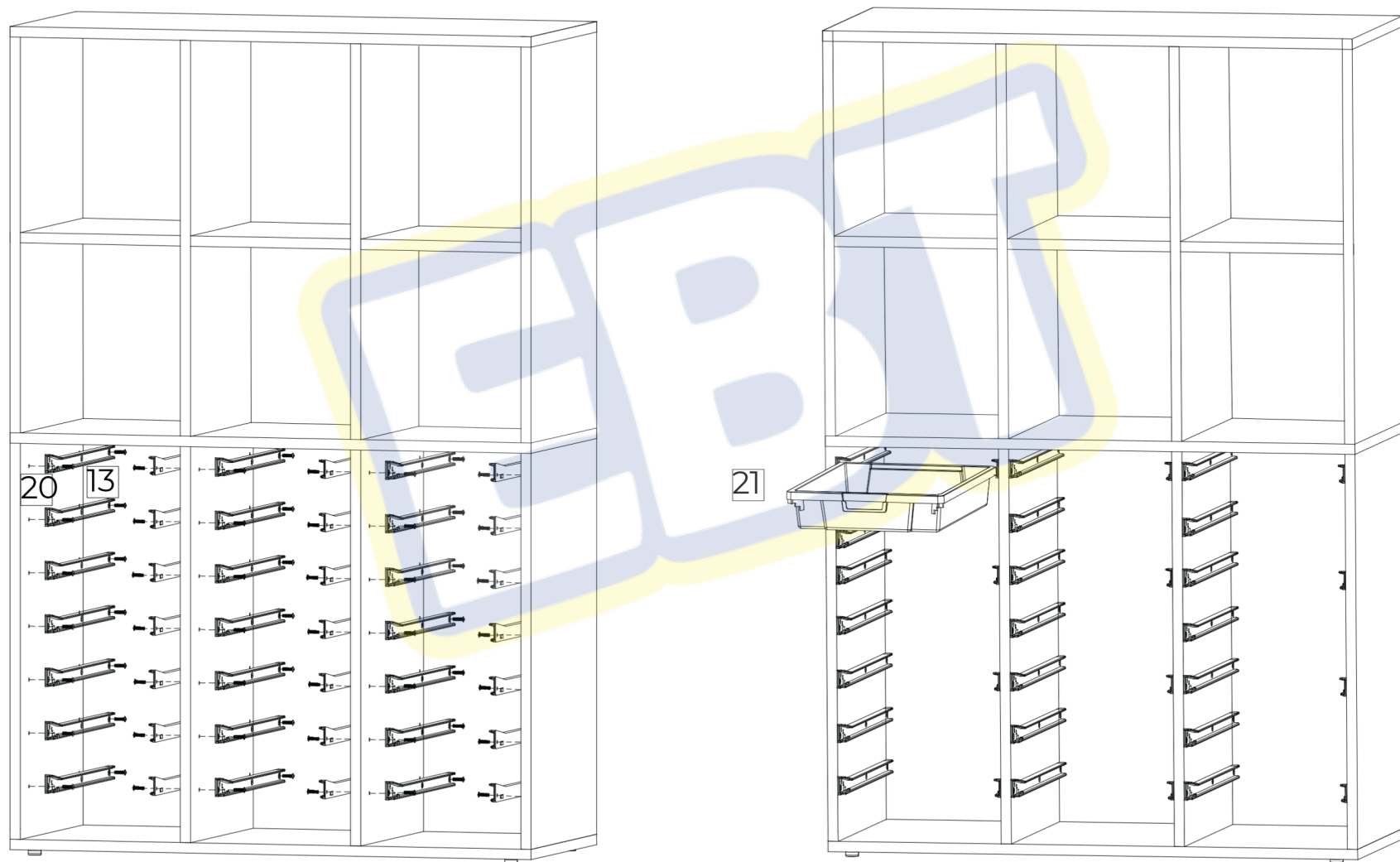

Tenga en cuenta la dirección de instalación de la pieza 20: la protuberancia debe mirar hacia arriba.



¡Instalación completa!  
Gracias por preferirnos :)